

Tool No:-WP/EX/336

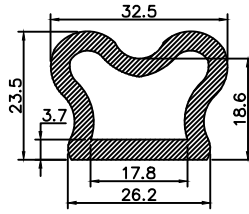

Tool No:-WP/EX/337

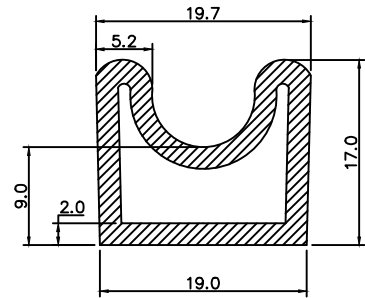

Tool No:-WP/EX/340

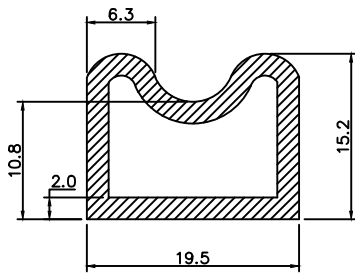

Tool No:-WP/EX/341

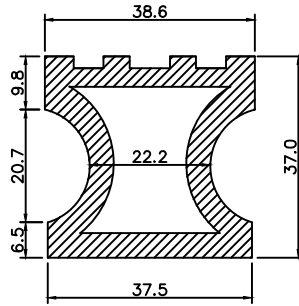

Tool No:-WP/EX/346

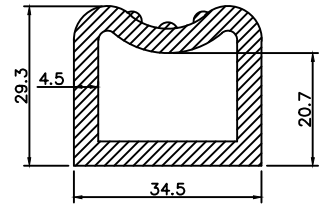

Tool No:-WP/EX/347

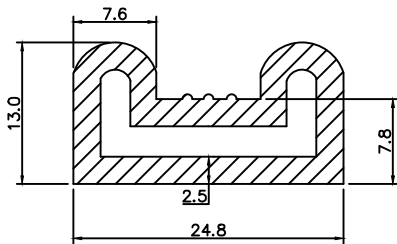

Tool No:-WP/EX/348

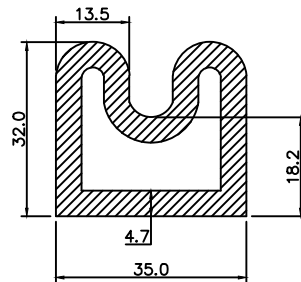

Tool No:-WP/EX/349

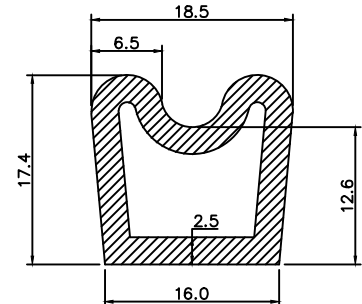

Tool No:-WP/EX/350



Western Polyrub India Pvt. Ltd.
Mumbai-400104

Description:- PAGE NO.9

Material:-
Drawn:- K.V
Checked:- S.Y

Hardness:-
colour:-

Title:- INFLATABLE DIE LIST

Part No.:- -----

Compound No.:- -----

Tool No.:- -----

Size:-

A4

Revision:- 01

Dimensions are in mm