

Tool No:-WP/EX/260

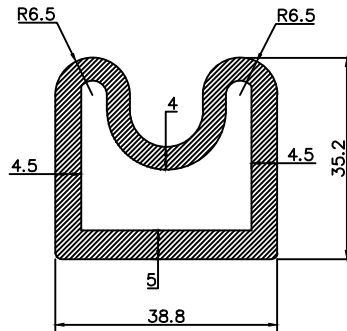

Tool No:-WP/EX/265

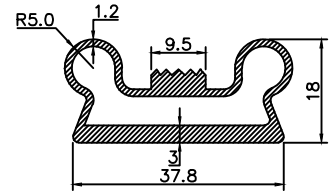

Tool No:-WP/EX/266

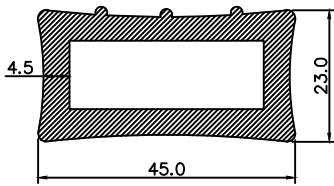

Tool No:-WP/EX/270

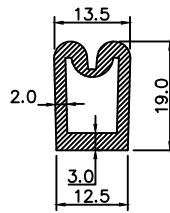

Tool No:-WP/EX/276

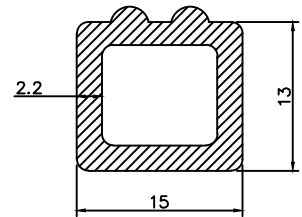

Tool No:-WP/EX/278

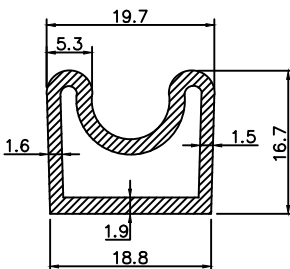

Tool No:-WP/EX/284

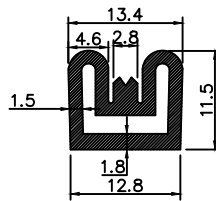

Tool No:-WP/EX/295

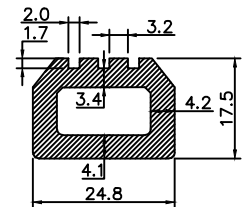

Tool No:-WP/EX/297



Western Polyrub India Pvt. Ltd.
Mumbai-400104

Description:- PAGE NO.7

Material:-

Drawn:- K.V

Checked:- S.Y

Hardness:-

colour:-

Title:- INFLATABLE DIE LIST

Part No:-

Compound No:-

Tool No:-

Size:-

A4

Revision:- 01

Dimensions are in mm